

WELLNESS

BATHTUBS



WELLNESS

BATHTUBS

- 2 **WHY SELECT
A NOVELLINI BATHTUB**
- 4 **MATERIALS AND DESIGN**
- 8 **OUR MASSAGE SYSTEMS**
- 11 **OUR WELLNESS FUNCTIONS**
- 12 **OUR BATHTUB COLLECTIONS**
- 15 **DIVINA**
DESIGN AND PLEASURE
- 35 **SENSE**
A COMPLETE RANGE OF JETS
AND MESSAGES
- 47 **CLASSIC**
INITIATION TO WHIRPOOL MESSAGES
- 55 **COMFORT**
BATH AND SHOWER ALL-IN-ONE
- 61 **NOVOTECH**
EXCLUSIVE DESIGN AND
TOP-OF-THE-LINE MATERIALS

WHY SELECT A NOVELLINI BATHTUB

MADE IN
ITALY



100% MADE IN ITALY

All our products are manufactured at our plant based in Mantua, Italy. Our mastery over the complete production chain allows us to ensure the highest quality levels in terms of the finished goods and components used.

CLIENT SERVICE UK

Our team works daily to offer customized solutions to your requests and to answer your queries. With our commitment to improve the quality of our services, we provide technical support to all our clients and product users. We provide After-Sales services in all of UK.

HEAD OFFICE / Borgo Virgilio - Mantua - Italy



CRAFTSMANSHIP

Proud of its history of over 50 years, Novellini became a European benchmark in the field of bathrooms, valued both by professionals as well as users. Since the beginning, we have been using the best technologies and the latest trends in terms of design to offer you a unique wellness experience.

EQUIPMENT

Based on the version, your bathtub will be delivered with all the equipment required for its installation: self-supporting tub feet or frame, head cushions, automatic emptying, fittings or filling system by emptying. All our bathtubs exist in versions with or without whirlpool massage.

STANDARDS

All our products are designed and made to be compliant with the most recent European standards in terms of quality and security. From raw materials to finished goods, including the assembly of various components, every phase is planned with attention, is subject to checks and is verified to guarantee the characteristics corresponding to the standards required by the European authorities.



MATERIALS

WE USE PREMIUM QUALITY MATERIALS SO YOUR BATHTUB PROVIDES YOU COMPLETE SATISFACTION

SYNTEK

This reinforced plastic material enables us to create models with highly varied designs. With a pleasant feel and easy handling, it has excellent insulating properties and provides exceptional comfort, since it quickly assumes the bath water temperature. The surface of Syntek is naturally anti-slip and guarantees optimal grip. Tested with a slope greater than 24°, our bathtubs comply with the PN 24 standard. Available in the collections Divina, Sense, Classic and Comfort.



glossy white
classic

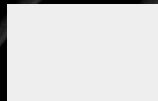

matte white
exclusive, soft
and silky

NOVOTECH

Extremely solid and highly aesthetic, this exclusive material contains a high percentage of natural mineral fillers and highly pure resins. Due to its extraordinary qualities, it allows us to create organic and sinuous forms in dynamic and sensual styles. The solidity of Novotech provides maximum security to free-standing bathtubs. Its smooth and silky feel is a real pleasure to touch. Available with the Novotech collection.

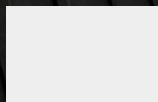

matte white

PANELLING

We offer a wide selection of panelling finishes to provide a traditional or unique style to your bathroom. Our water-resistant panelling has solid design that holds very well over time. Panelling is available in assorted finishes in our furnishings collection.

LAMINATED SYNTEK, MATCHING THE FINISH OF THE BATHTUB



white
glossy



matte
white

4 WOOD VARIANTS



White wood



grain



BURLINGTON



wenge

3 SHADES OF NATURAL CLAY



PECE



POLVERE



TORTORA



DESIGN

DESIGN AND VISUAL PLEASURE CONTRIBUTE LARGELY TO YOUR WELL-BEING. THIS IS WHY WE ASK THE BEST DESIGNERS TO DEVISE THE FORMS AND ERGONOMICS OF OUR BATHTUBS.

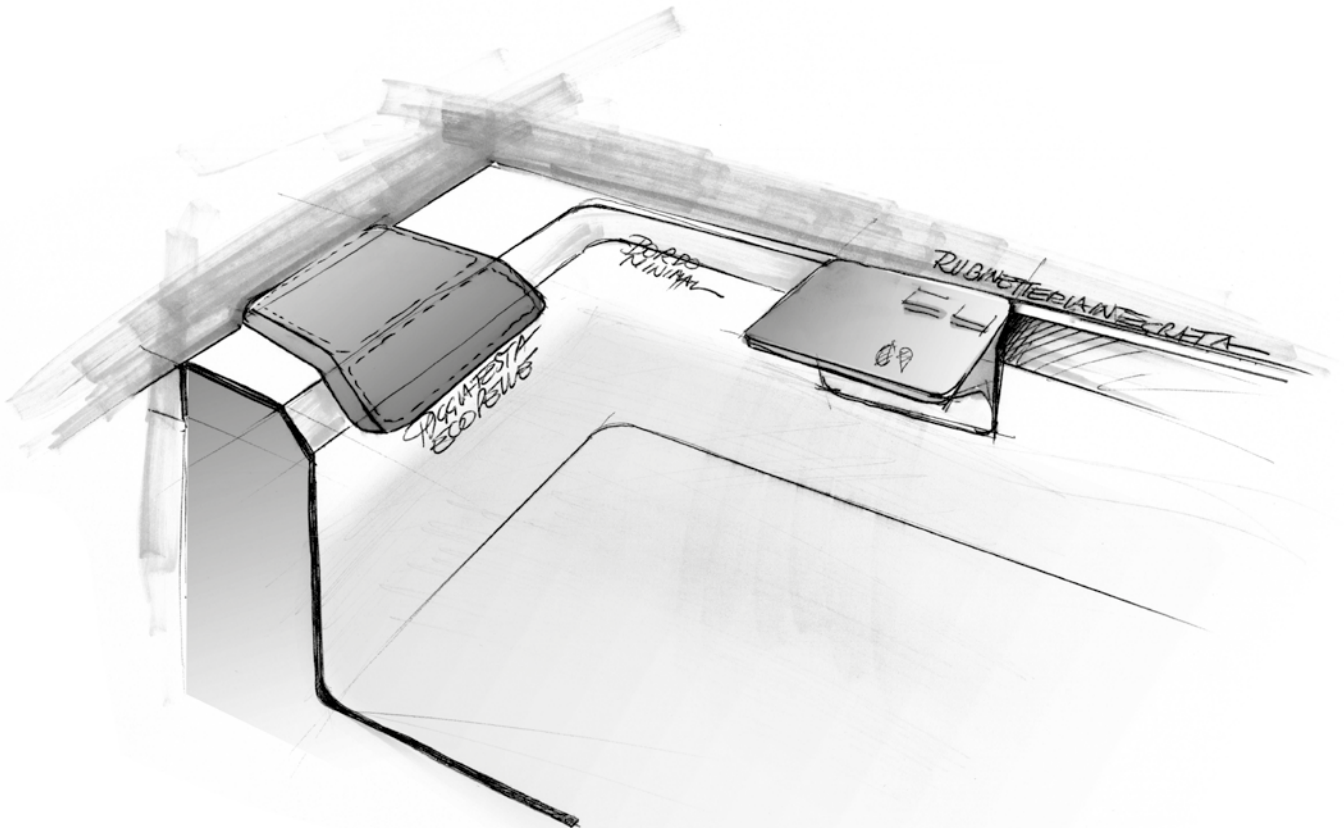

MARCO PELLICI
DESIGNER



SIMONE MICHELI
DESIGNER



MASSIMO FARINATTI
DESIGNER



We bring the excellence of Made in Italy design to the centre of your bathroom space. Our designers engineer the environments and individual elements so you can feel the wellness upon first look. Comfort and ergonomics are seamlessly blended with style and an aesthetic vision to bring you the bathroom you desire.

ALL THE PLEASURES OF WHIRLPOOL MASSAGES

Our massage offer
will serve your needs.

To unwind, to tone up
or to take care of your skin...
Among our massage systems,
you will certainly find
the one that perfectly fulfils
your wellness requirements.





SILENCE

A whirlpool bath is a privileged moment that lets you focus fully on your well-being. This is why we pay a lot of attention to comfort in terms of sound levels. The pumps and wind tunnels of our bath tubs have been studied to preserve the calm during your whirlpool sessions and lull you with the soft sound of water in movement.



YOUR WELL-BEING IN A SINGLE GESTURE

Irrespective of the collection you select, you will be enamoured by the simplicity of use of the massages. We have studied our keyboards and remote controls to allow you easy access to all functionalities.

OUR MASSAGE SYSTEMS



RELAXED

Are you searching for a means to relax?

> Select the **Air** massage.

Air caresses the body and has a relaxing effect in all gentleness. The air bubbles give you a sensation of lightness, fighting fatigue and reducing tension due to stress. Air is projected through injectors provided at the base of the bathtub.



TONIC

Do you prefer a tonic and stimulating massage instead?

> Take a look at the **Water** massage.

Water provides a deep massage that helps improve blood circulation and reduce muscle tension. Water massage removes toxins and helps plump up the skin. Water massage with adjustable speed is produced by nozzles available on the vertical walls of the bathtub and is linked to a pump.

CARING FOR YOUR BATHTUB

It is necessary to take care of your bathtub to derive benefit from it for a long number of years.



AUTOMATIC DRYING

All our Air systems have an automatic drying system that starts when the bathtub is emptied to clean the air streams and remove the remaining water and impurities.



DISINFECTION

It is indispensable to regularly clean (twice or thrice a month) the water pipes of your bathtub. To do this, we suggest using products customized for the whirlpool bathtubs that protect the equipment.

Rinse your bathtub, fill it with water while adding the disinfectant and start the disinfection program or simply a water massage if your bathtub does not have a special program.





RELAXED AND TONIC

Do your requirements change according to your lifestyle?

- > Take massages from the **Mixed** system.

A combination of the Water and Air systems, the mixed massage fulfils all your wellness requirements and offers you the relaxing benefits of air and the invigorating properties of water. The bathtub has water nozzles on the vertical walls and air injectors at the base of the bathtub.



CARE

Do you wish to offer your skin and body a rejuvenating bath?

- > Our **Natural Air** exclusive care system is made for you

The Natural Air system mixes the pleasure of a relaxing bath with care for the skin. Thousands of micro air bubbles mix with the water jet and form a delicate cloud of oxygen that washes over the skin and improves its elasticity. One or two micro-bubble dispensers are placed on the walls of the bathtub.

NATURAL**AIR** TECHNOLOGY

The micro air bubbles, up to a 100 times smaller than the air bubbles produced by a classic air system, saturate water by transforming it into a soft mixture and giving it the feel of a delicate milk bath.

They stick to the skin, removing impurities, dead cells and sebum. The soft sensation on the skin lasts all day long and a 20 minute session alone suffices to derive maximum benefit.

The oxygen released by the Natural Air system stimulates the production of collagen, an important protein in our body, which plays an essential role in the functioning of organs and tissues. Collagen increase is a natural anti-ageing remedy that reduces wrinkles and smoothens your skin to return its vitality.





IT IS NOT NECESSARY
TO RUN ALL AROUND THE WORLD
TO FIND
INNER PEACE.

YOU CAN FIND YOUR SAFE HAVEN AT HOME.
SINK INTO YOUR BATH AND SURRENDER TO THE MAGIC OF WATER.

A 15-20 MINUTE SESSION SUFFICES TO RESTORE
YOUR TRANQUILITY AND VITAL ENERGIES.

WELLNESS

**TO MAKE EACH OF YOUR WHIRLPOOL SESSIONS UNIQUE, OUR
BATHTUBS OFFER YOU FUNCTIONS THAT TRANSPORT
YOU INTO A WELLNESS BUBBLE**

MUSIC

Listen to your favourite pieces of music during your bath.

Bluetooth

A Bluetooth connection allows you to connect your smartphone, tablet or PC to the bathtub so you can listen to your playlists. You monitor your music through your playback. The Bluetooth technology is provided in bathtubs from the Divina and Sense collections.

RDS Radio

Listen to your favourite radio programs! You can manage your radio channels through a remote. The RDS Radio function is available in the Sense bathtubs.

CHROMOLIGHT

Liven up your moments of relaxation with a play of multicoloured lights diffused in the bath water. Relaxing, energizing or captivating,... You can let the colours play or select a colour of your choice.



OUR COLLECTIONS

EACH OF OUR BATHTUB COLLECTIONS
REFLECTS A SPECIFIC WELLNESS APPROACH



DIVINA
DESIGN
AND PLEASURE
p. 15



SENSE
COMPLETE RANGE OF
JETS AND MESSAGES
p. 35



DIVINA 35

DIVINA F 35

DIVINA C

DIVINA O

DIVINA DUAL



SENSE 3

SENSE 4

SENSE DUAL

BATHTUB MATERIAL

Syntek
glossy white
matte white



Syntek
glossy white
matte white



MASSAGE SYSTEMS

- RELAXED**
Hydro Air
- TONIC**
Whirlpool
- RELAXED + TONIC**
Hydro Plus
- CARE**
Natural Air
- CARE + TONIC**
Natural Air + Whirlpool

- RELAXED**
Dream Air
- TONIC**
Hydro
- RELAXED + TONIC**
Hydro Plus/ Dream Plus

WELLNESS FUNCTIONS (based on the system)

-  Backlit water nozzles
-  Bluetooth
-  Re-heater-stabilizer of water temperature (Divina Dual)

-  Multicoloured spot
-  Bluetooth + RDS Radio
-  Re-heater-stabilizer of water temperature

CONTROL





CLASSIC
INITIATION TO
WHIRPOOL MESSAGES
p. 47

COMFORT
BATH AND SHOWER
ALL-IN-ONE
p. 55

NOVOTECH
EXCLUSIVE DESIGN AND
TOP-OF-THE-LINE MATERIALS
p. 61



CALOS 2.0

CALYPSO



VOGUE



IRIS



INFINITIVE



SHIP

Syntek
glossy white
matte white (Calos 2.0)

Syntek
glossy white

Novotech

TONIC
Hydro/ Hydro+Disinfection

RELAXED + TONIC
Hydro Plus

CARE
Natural Air



Peripheral LED light,
optional



Touch control
keyboard



Touch control
keyboard



Control
button

**DEPTH
50 CM FOR
OPTIMAL
IMMERSION**

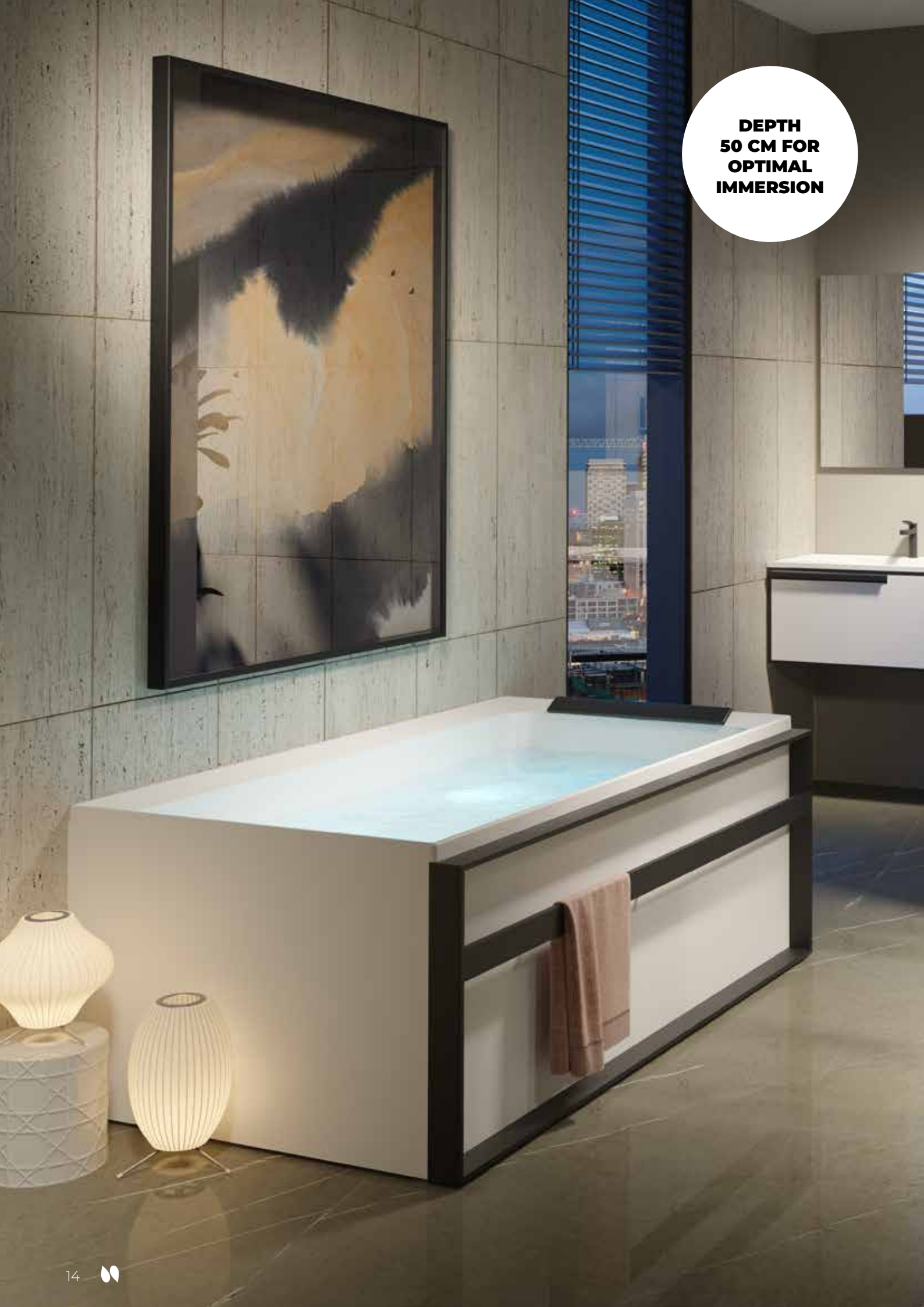



ONLINE CONFIGURATION
novellini.fr/yourproduct.html

DIVINA COLLECTION

DESIGN AND PLEASURE

The real star of the Novellini bathtubs, the Divina collection sets itself apart by its soft and elegant lines. The original design of these bathtubs with bevelled edges is highlighted by the quality and uniqueness of materials. Easy to use, they offer a very wide range of water and air massages. Assuredly pleasing to the body and the eyes!



Sensitive, intuitive keyboard integrated on the edge of the bathtub. A light touch on a key switches the function on.

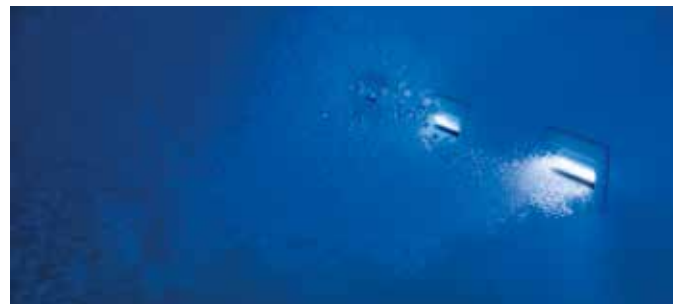

The water nozzles in strips enable ensuring full body coverage.

To better target the body parts that require stimulation, the direction of these jets can be adjusted.

The nozzles are back-lit in the Hydro Plus and Natural Air+Whirlpool versions.



The air injectors placed at the base of the bathtub are flush and almost invisible, providing maximum comfort during your bathing experience.



All the bathtubs of the Divina series have a practical snap emptying function. The cover cap is made in the finish selected for the bathtub.

DIVINA 35

RECTANGULAR BATHTUB

Height of the edge 3.5 cm

VERSIONS

EQUIPMENT

BUILT-IN WITH FEET

head cushions
snap emptying

WITH SELF-SUPPORTING FRAME

head cushions
snap emptying

STANDARD WITHOUT WHIRLPOOL SYSTEM	RELAXED HYDRO AIR AIR SYSTEM	TONIC WHIRLPOOL WATER SYSTEM	RELAXED + TONIC HYDRO PLUS MIXED SYSTEM	CARE NATURAL AIR MICRO AIR BUBBLE SYSTEM	CARE + TONIC MICRO AIR + WATER BUBBLE SYSTEM	NATURAL AIR + WHIRLPOOL
•						
•	•	•	•	•	•	•

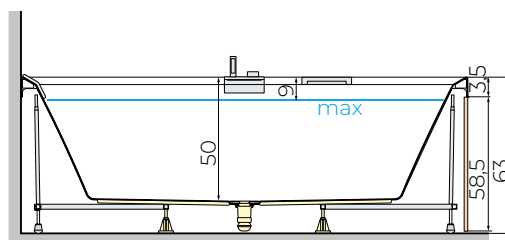
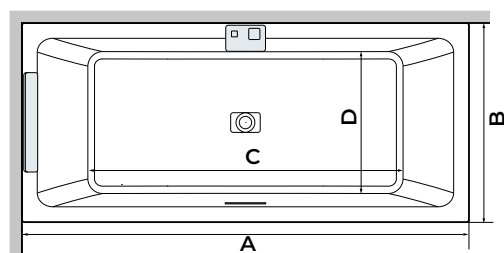

MODEL	A	B	C	D	CAPACITY
160x70	160 cm	70 cm	105 cm	46 cm	260 litres
170x70	170 cm	70 cm	115 cm	46 cm	280 litres
170x75	170 cm	75 cm	115 cm	51 cm	300 litres
180x80	180 cm	80 cm	125 cm	56 cm	350 litres
180x100	180 cm	100 cm	125 cm	76 cm	430 litres
190x90	190 cm	90 cm	135 cm	66 cm	420 litres

OPTIONS

Fittings, filling by emptying, object-holding tablets, see pages 28-29

Can be completed with a YOUNG 1V or YOUNG 1BSV bath screen, see page 29

Panelling for installation in a corner, angle, in a U against the wall or free-standing.

PANELLING FINISHES

WHITE
matching the bathtub



GLOSSY WHITE MATTE WHITE

CLAY



PECE TORTORA POLVERE

WOOD



WHITE WOOD GRAIN BURLINGTON WENGE

CAN BE LINKED WITH:

— BLACK FRAME BLACK FRAME BLACK FRAME BLACK FRAME BLACK FRAME BLACK FRAME BLACK FRAME BLACK FRAME
WHITE FRAME WHITE FRAME WHITE FRAME WHITE FRAME WHITE FRAME WHITE FRAME WHITE FRAME WHITE FRAME

Frame panelling available with the Divina 35 model only

DIVINA 35



DIVINA

RECTANGULAR BATHTUB

Height of the edge 8 cm

VERSIONS	EQUIPMENT	STANDARD WITHOUT WHIRLPOOL SYSTEM	RELAXED HYDRO AIR AIR SYSTEM	TONIC WHIRLPOOL WATER SYSTEM	RELAXED + TONIC HYDRO PLUS MIXED SYSTEM	CARE NATURAL AIR MICRO AIR BUBBLE SYSTEM	CARE + TONIC MICRO AIR + WATER BUBBLE SYSTEM
BUILT-IN WITH FEET	head cushions snap emptying	•					
WITH SELF-SUPPORTING FRAME	head cushions snap emptying	•	•	•	•	•	•



GLOSSY WHITE

MATTE WHITE

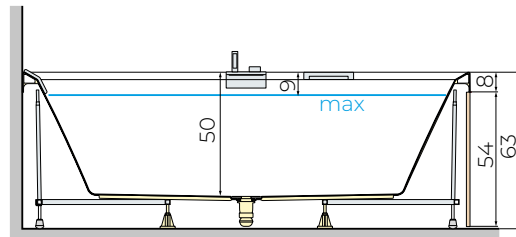
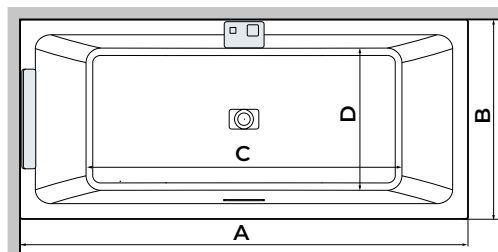

MODEL	A	B	C	D	CAPACITY
160x70	160 cm	70 cm	105 cm	46 cm	260 litres
170x70	170 cm	70 cm	115 cm	46 cm	280 litres
170x75	170 cm	75 cm	115 cm	51 cm	300 litres
180x80	180 cm	80 cm	125 cm	56 cm	350 litres
180x100	180 cm	100 cm	125 cm	76 cm	430 litres
190x90	190 cm	90 cm	135 cm	66 cm	420 litres

OPTIONS

Fittings, filling by emptying, object-holding tablets, see pages 28-29

Can be completed with a YOUNG 1V or YOUNG 1BSV bath screen, see page 29

Panelling for installation in a corner, angle, in a U against the wall or free-standing.

PANELLING FINISHES

WHITE
matching the bathtub



GLOSSY WHITE

MATTE WHITE

CLAY



PECE

TORTORA

POLVERE

WOOD



WHITE WOOD

GRAIN

BURLINGTON

WENGE

Frame panelling not available with the Divina model edge 8 cm

DIVINA



DIVINA O

ASYMMETRIC BATHTUB

Height of the edge 8 cm

VERSIONS	EQUIPMENT
BUILT-IN WITH FEET	head cushions snap emptying
WITH SELF-SUPPORTING FRAME	head cushions snap emptying

STANDARD WITHOUT WHIRLPOOL SYSTEM	RELAXED HYDRO AIR AIR SYSTEM	TONIC WHIRLPOOL WATER SYSTEM	RELAXED + TONIC HYDRO PLUS MIXED SYSTEM	CARE NATURAL AIR MICRO AIR BUBBLE SYSTEM	CARE + TONIC MICRO AIR + WATER BUBBLE SYSTEM	NATURAL AIR + WHIRLPOOL
•						
•	•	•	•	•	•	•

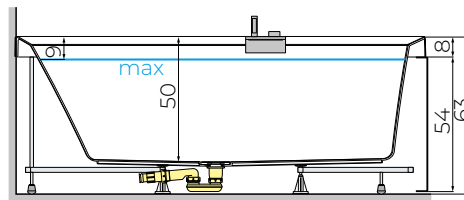
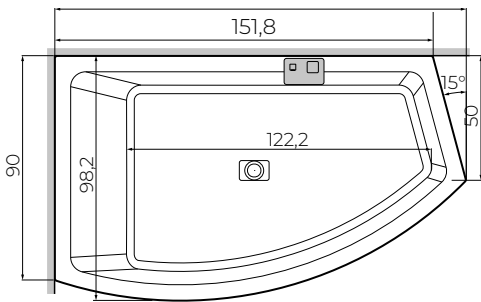
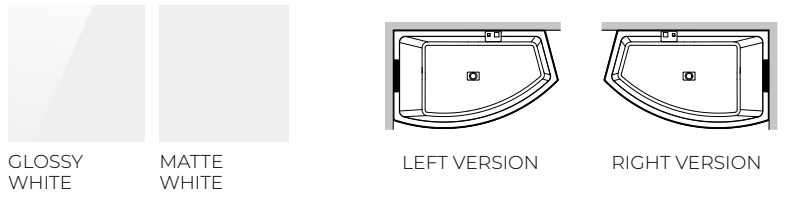

MODEL	CAPACITY
165x98 cm	360 litres

OPTIONS

Fittings, filling by emptying, object-holding tablets, see pages 28-29
Panelling for installation with angle

PANELLING FINISHES



DIVINA O



DIVINA C

ANGLED BATHTUB

Height of the edge 8 cm

VERSIONS	EQUIPMENT
BUILT-IN WITH FEET	head cushions snap emptying
WITH SELF-SUPPORTING FRAME	head cushions snap emptying

STANDARD WITHOUT WHIRLPOOL SYSTEM	RELAXED HYDRO AIR AIR SYSTEM	TONIC WHIRLPOOL WATER SYSTEM	RELAXED + TONIC HYDRO PLUS MIXED SYSTEM	CARE NATURAL AIR MICRO AIR BUBBLE SYSTEM	CARE + TONIC MICRO AIR + WATER BUBBLE SYSTEM
•					
•	•	•	•	•	•

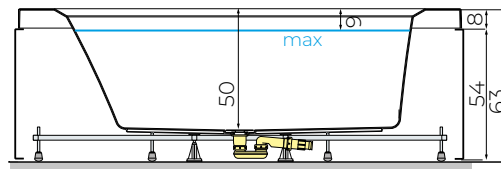
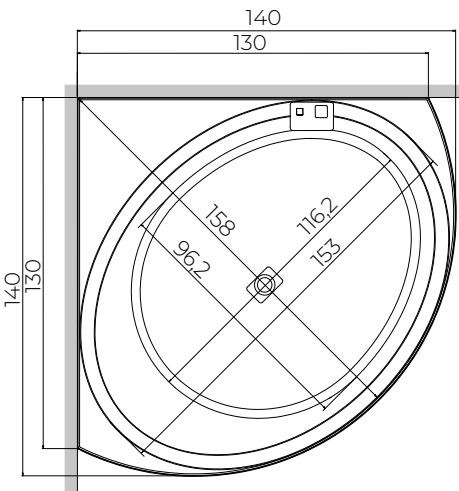

MODEL	CAPACITY
140x140 cm	400 litres

OPTIONS

Fittings, filling by emptying, object-holding tablets, see pages 28-29
Panelling for installation with angle

PANELLING FINISHES

WHITE matching the bathtub		CLAY			WOOD			
GLOSSY WHITE	MATTE WHITE	PECE	TORTORA	POLVERE	WHITE WOOD	GRAIN	BURLINGTON	WENGE

DIVINA C



DIVINA F

FREE-STANDING BATHTUB
Height of the edge 8 cm

VERSIONS	EQUIPMENT
BUILT-IN WITH FEET	head cushions snap emptying
WITH SELF-SUPPORTING FRAME	head cushions snap emptying Integrated panelling

STANDARD WITHOUT WHIRLPOOL SYSTEM	RELAXED HYDRO AIR AIR SYSTEM
•	
•	•

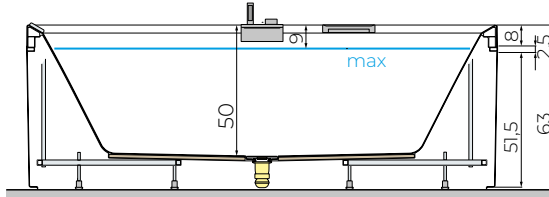
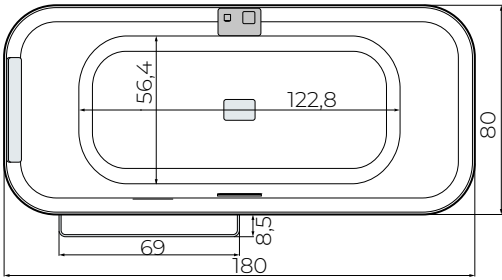

PANELLING INTEGRATED

For free-standing installation
 Series with the Divina F bathtubs with frame.
 Finishing matching the bathtub + metal belt with soap and towel holders

MODEL	CAPACITY
180x80 cm	400 litres

DIVINA F 35

FREE-STANDING BATHTUB
HEIGHT OF THE EDGE 3.5 CM

VERSIONS	EQUIPMENT
BUILT-IN WITH FEET	head cushions snap emptying

STANDARD WITHOUT WHIRLPOOL SYSTEM
•



OPTIONS FOR DIVINA F AND DIVINA F 35
 Fittings, object-holding tablet, see pages 28-29

DIVINA F



MASSAGE SYSTEMS

RELAXED

HYDRO AIR

Air massage system
 • 16 jets Airpool
 400 W



Air Massage continuous or alternate

DIVINA AND DIVINA 35

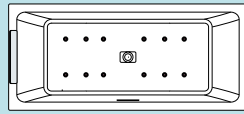

DIVINA O

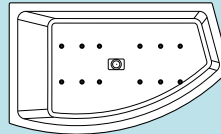

DIVINA C

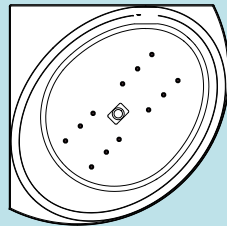

DIVINA F

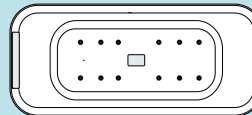

HYGIENE

AIR: Drying Air pipes at the end of the bath

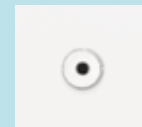

Air injector

TONIC

WATER SYSTEM

Water massage system
 • 6 lateral water nozzles
 900 W



Water Massage at variable speed from fastest to slowest with the possibility to stop at a speed

DIVINA AND DIVINA 35

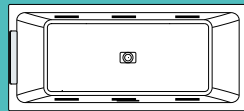

DIVINA O

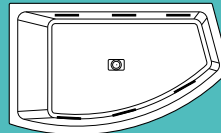

DIVINA C

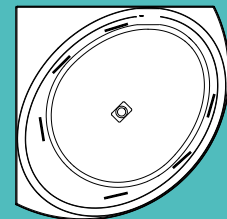

HYGIENE

WATER: Use the products customized for whirlpool bathtubs to disinfect the water stream: fill your bathtub, pour the product in the bathtub water and start the Water massage.



Adjustable water nozzle in the shape of a strip

RELAXED AND TONIC

HYDRO PLUS

Mixed massage system
 • 16 jets Airpool
 400 W
 • 6 lateral, back-lit water jets
 900 W



Air Massage continuous or alternate



Water Massage at variable speed from fastest to slowest with the possibility to stop at a speed



Chromolight: back-lit nozzles with diffusion of multicoloured lights with the possibility to stop at a colour



Music reader stored on a telephone or tablet via Bluetooth connection

DIVINA AND DIVINA 35

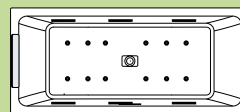

DIVINA C

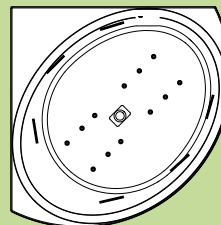

DIVINA O

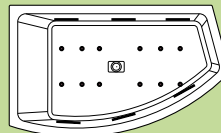

HYGIENE

AIR: Drying Air pipes at the end of the bath

WATER: Use the products customized for whirlpool bathtubs to disinfect the water stream: fill your bathtub, pour the product in the bathtub water and start the Water massage.

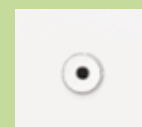

Air injector



Adjustable water nozzle in the shape of a strip



CARE

NATURAL AIR

Micro air bubble massage system

- 1 diffuser Natural Air 1,050 W



Air micro bubble diffusion in the bath water
Operation in start/ stop mode

DIVINA AND DIVINA 35



DIVINA O

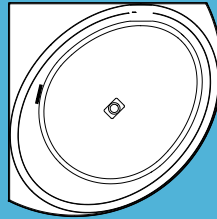
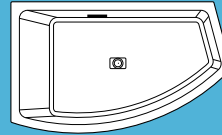

Natural Air dispenser

CARE AND TONIC

NATURAL AIR + WHIRLPOOL

Water massage system with micro air bubble diffusion

- 6 lateral, back-lit water nozzles 900 W
- 1 dispenser Natural Air 1,050 W



Air micro bubble diffusion in the bath water
Operation in start/ stop mode



Water Massage at variable speed from fastest to slowest with the possibility to stop at a speed



Chromolight: back-lit nozzles with diffusion of multicoloured lights with the possibility to stop at a colour



Music reader stored on a telephone or tablet via Bluetooth connection

DIVINA AND DIVINA 35

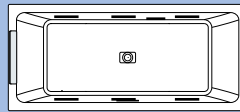

DIVINA C

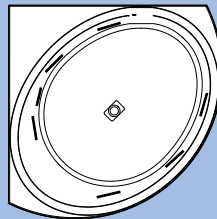

DIVINA O

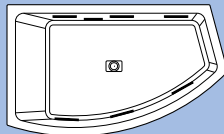

HYGIENE

WATER: Use the products customized for whirlpool bathtubs to disinfect the water stream: fill your bathtub, pour the product in the bathtub water and start the Water massage.



Natural Air dispenser



Adjustable water nozzle in the shape of a strip



WHIRLPOOL WATER NOZZLES



BACKLIT WATER NOZZLES HYDRO PLUS and NATURAL AIR+WHIRLPOOL



HYDRO AIR AIR INJECTORS



MICRO AIR BUBBLE DIFFUSER NATURAL AIR and NATURAL AIR+WHIRLPOOL



BLUETOOTH MUSIC
diffusion of music stored on external devices through the bathtub walls
HYDRO PLUS and NATURAL AIR+WHIRLPOOL

OPTIONS



BATHTUB EDGE FITTINGS

Constant flow, variable temperature

- cascade filling nozzle
- showerhead with anti-drip pipe



FILLING BY EMPTYING

This system combines the filling, emptying and overflow function and advantageously replaces the classic pouring nozzle to give you ease in use.



OBJECT-HOLDING SHELF

Shelf to be fixed on the edge of the bathtub. Its internal structure provides it exceptional solidity and the polyurethane coating makes it pleasant to use.

Customized for all bathtubs from the DIVINA collection.



OBJECT-HOLDING TRAY

This tray can be placed at a location of your choice. Its solid structure makes it particularly stable. Customized for the DIVINA 35, DIVINA and DIVINA F bathtubs.



BATH SCREENS

The rectangular DIVINA 35 and DIVINA bathtubs can be completed with bath screens from the Novellini range:

- YOUNG TV: bath screen with 1 rotatable pane
- YOUNG 1 BSV: bath screen with 1 rotatable and foldable pane

Glass with 6 mm thickness. White, Silver, Chrome or Matte black outlines
A customization kit is required for installation

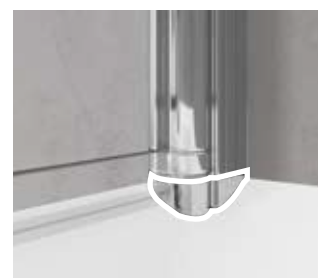

HYDROSILENCE KIT

The turbines and pumps fitted in our bathtubs are soundless to let you enjoy your massages to the utmost. The Hydrosilence kit additionally enables reducing noise and vibrations to make your whirlpool sessions even more quiet.

DIVINA DUAL

TWO-SEAT BATHTUB

VERSIONS

EQUIPMENT

WITH SELF-SUPPORTING FRAME 2 head cushions seat

STANDARD WITHOUT WHIRLPOOL SYSTEM	TONIC WHIRLPOOL WATER SYSTEM	WHIRLPOOL WATER SYSTEM WITH CASCADE	RELAXED + TONIC MIXED SYSTEM WHIRLPOOL + AIRPOOL	CARE + TONIC MICRO AIR + WATER BUBBLE SYSTEM NATURAL AIR + WHIRLPOOL	AIR + WATER MICRO BUBBLE SYSTEM NATURAL AIR + WHIRLPOOL WITH CASCADE
•	•	•	•	•	•

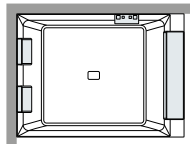
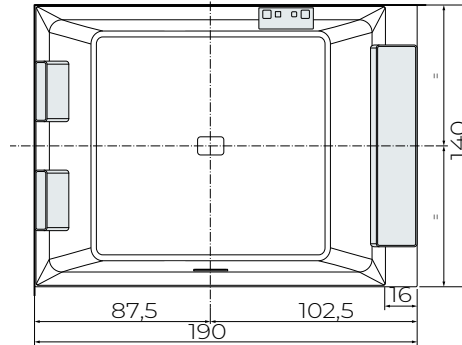
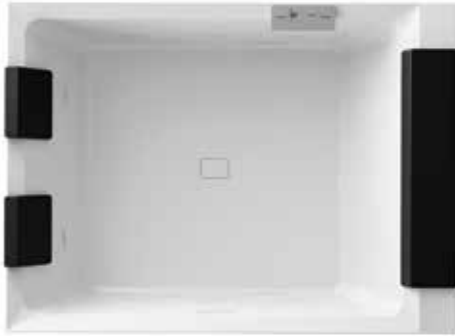

LEFT VERSION

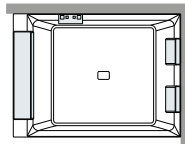

RIGHT VERSION

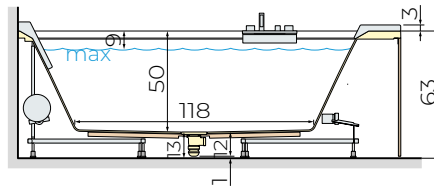

INSTALLATION POSSIBILITIES:

- IN A CORNER with 1 facade panelling
- IN ANGLE with 1 facade panelling and 1 lateral panelling
- IN U with 1 facade panelling and 2 lateral panellings
- IN FREE-STANDING with 2 facade panellings and 2 lateral panellings

OPTIONS



- BATHTUB EDGE FITTINGS WITH CONSTANT FLOW**
- cascade filling nozzle
 - showerhead with anti-drip pipe
 - temperature changer
 - reverser

MODEL	CAPACITY
190x140 cm	650 litres

PANELLING



WHITE PANELLING OR WOOD OR CLAY FINISH



PANELLING WITH A WHITE FRAME IN ALUMINIUM



PANELLING WITH A BLACK FRAME IN ALUMINIUM

PANELLING FINISHES

WHITE
matching the bathtub



GLOSSY WHITE

MATTE WHITE

CLAY



PECE

TORTORA

POLVERE

WOOD



WHITE WOOD

GRAIN

BURLINGTON

WENGE

CAN BE LINKED WITH:

— BLACK FRAME

BLACK FRAME WHITE FRAME BLACK FRAME WHITE FRAME BLACK FRAME WHITE FRAME

BLACK FRAME WHITE FRAME BLACK FRAME WHITE FRAME BLACK FRAME WHITE FRAME BLACK FRAME WHITE FRAME

DIVINA DUAL



MASSAGE SYSTEMS

TONIC

WHIRLPOOL

Water massage system

- 8 lateral water nozzles
900 W + 900 W

 Water Massage On/Off

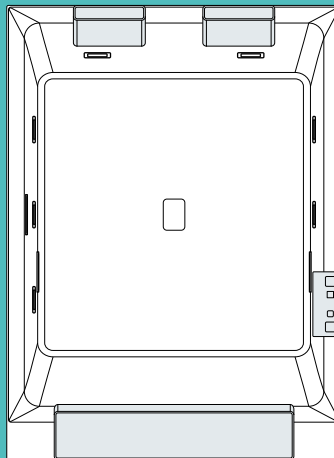

HYGIENE

WATER: Use the products customized for whirlpool bathtubs to disinfect the water stream: fill your bathtub, pour the product in the bathtub water and start the Water massage.



Adjustable water nozzle in the shape of a strip

TONIC

WHIRLPOOL WITH CASCADE

Water massage system

- 8 lateral water nozzles

900 W + 900 W

- Water strip cascade LED lighting
550 W

 Water Massage at variable speed from fastest to slowest with the possibility to stop at a speed

 Water strip cascade, operation in closed circuit

 Chromolight: back-lit nozzles with diffusion of multicoloured lights with the possibility to stop at a colour

 Music reader stored on a telephone or tablet via Bluetooth connection

 Disinfection program

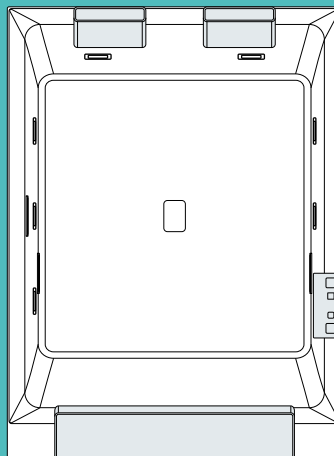

HYGIENE

WATER: Water stream disinfection program. Use products customized for whirlpool bathtubs. Pour the product in the tank planned for this and start the disinfection program.



Adjustable water nozzle in strips

RELAXED AND TONIC

WHIRLPOOL + AIRPOOL

Water massage system

- 20 air injectors
400 W
- 8 lateral water nozzles
900 W + 900 W

 Air Massage continuous or alternate

 Water Massage at variable speed from fastest to slowest with the possibility to stop at a speed

 Chromolight: back-lit nozzles with diffusion of multicoloured lights with the possibility to stop at a colour

 Music reader stored on a telephone or tablet via Bluetooth connection

 Disinfection program

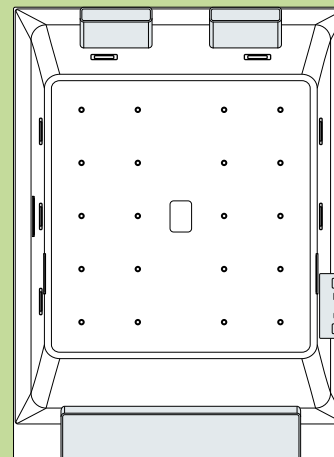

HYGIENE

AIR: Drying Air pipes at the end of the bath

WATER: Water stream disinfection program. Use products customized for whirlpool bathtubs. Pour the product in the tank planned for this and start the disinfection program.

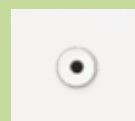

Air injector



Adjustable water nozzle in the shape of a strip







CARE AND TONIC

WHIRLPOOL + NATURAL AIR

Water massage system with micro air bubble diffusion

- 8 lateral water nozzles 900 W + 900 W
- 2 Natural Air diffusers 1,050 W

-  Natural Air: micro air bubble diffusion in the bath water
Operation in start/ stop mode
-  Water Massage at variable speed from fastest to slowest with the possibility to stop at a speed
-  Chromolight: back-lit nozzles with diffusion of multicoloured lights with the possibility to stop at a colour
-  Temperature re-heater: maintains the bath water temperature
-  Disinfection program

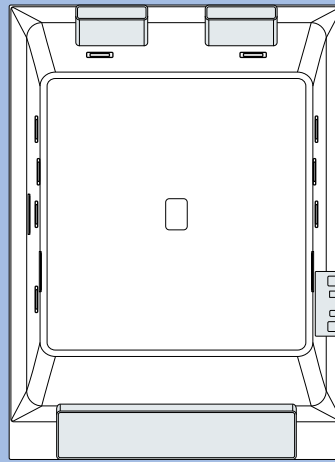

HYGIENE

WATER: Water stream disinfection program. Use products customized for whirlpool bathtubs. Pour the product in the tank planned for this and start the disinfection program.



Natural Air diffuser









Adjustable water nozzle in the shape of a strip

CARE AND TONIC

WHIRLPOOL + NATURAL AIR WITH CASCADE

Water massage system with micro air bubble diffusion

- 8 lateral water nozzles 900 W + 900 W
- 2 Natural Air diffusers 1,050 W
- Water strip cascade LED lighting 550 W

-  Natural Air: micro air bubble diffusion in the bath water
Operation in start/ stop mode
-  Water Massage at variable speed from fastest to slowest with the possibility to stop at a speed
-  Water strip cascade, operation in closed circuit
-  Chromolight: back-lit nozzles with diffusion of multicoloured lights with the possibility to stop at a colour
-  Temperature re-heater: maintains the bath water temperature
-  Disinfection program

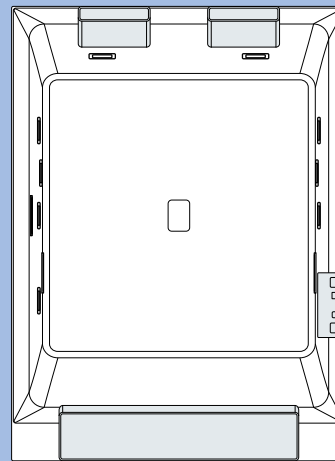

HYGIENE

WATER: Water stream disinfection program. Use products customized for whirlpool bathtubs. Pour the product in the tank planned for this and start the disinfection program.



Natural Air diffuser



Adjustable water nozzle in the shape of a strip



WHIRLPOOL WATER NOZZLES



BACKLIT WATER NOZZLES
- WHIRLPOOL WITH CASCADE
- WHIRLPOOL+AIRPOOL
- NATURAL AIR+WHIRLPOOL
- NATURAL AIR+WHIRLPOOL WITH CASCADE



AIR INJECTORS
WHIRLPOOL+AIRPOOL



MICRO AIR BUBBLE DIFFUSER
- NATURAL AIR+WHIRLPOOL
- NATURAL AIR+WHIRLPOOL WITH CASCADE



BLUETOOTH MUSIC
diffusion of music stored on external devices through the walls of the bathtub.
- WHIRLPOOL WITH CASCADE
- WHIRLPOOL+AIRPOOL
- NATURAL AIR+WHIRLPOOL
- NATURAL AIR+WHIRLPOOL WITH CASCADE



CASCADE BACKLIT WATER STRIP
- WHIRLPOOL WITH CASCADE
- NATURAL AIR+WHIRLPOOL WITH CASCADE



TEMPERATURE RE-HEATER-STABILIZER
maintains bath water temperature at its initial level when the Water massage is in progress
- NATURAL AIR+WHIRLPOOL
- NATURAL AIR+WHIRLPOOL WITH CASCADE



SENSE COLLECTION

A COMPLETE RANGE OF JETS AND MESSAGES

The Sense collection has been made to offer you perfect comfort and timeless aesthetic.

We studied where to place the jets to act on the sensitive areas of the body and provide you maximum relaxation. The air and water massage combinations will fulfil your expectations in terms of relaxation and vitality.



Touch screen remote control Touch Screen enables accessing the bathtub functions easily.



The Sense collection jets have been created to offer complete massages. Their positioning has been specially examined to help the reflex areas of the body, with specific attention to the dorsal and plantar areas.



To help you live exceptional moments of relaxation, we have provided all the Sense massage systems with a multicoloured chromo spot, that will plunge you into relaxing or dynamic ambiances.



All the systems of the Sense collection contain speakers to let you enjoy the music diffused by Bluetooth connection or to listen to your favourite radio channels.

SENSE 3

RECTANGULAR BATHTUB

Ergonomic recliner at the back



VERSIONS

EQUIPMENT

BUILT-IN WITH FEET

head cushions
automatic emptying

WITH SELF-SUPPORTING FRAME

head cushions
Automatic emptying

STANDARD WITHOUT WHIRLPOOL SYSTEM	RELAXED DREAM AIR AIR SYSTEM	TONIC HYDRO WATER SYSTEM	RELAXED + TONIC HYDRO PLUS MIXED SYSTEM	DREAM PLUS MIXED SYSTEM
•				
•	•	•	•	•



GLOSSY WHITE

MATTE WHITE

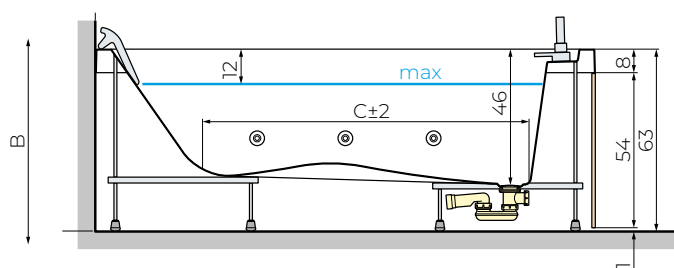
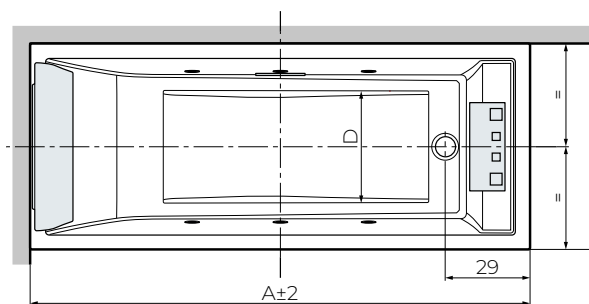

MODEL	A	B	C	D	CAPACITY
170x70	170 cm	70 cm	110.7 cm	47.5 cm	205 litres
170x75	170 cm	75 cm	110.7 cm	52.5 cm	225 litres
180x80	180 cm	80 cm	114.2 cm	57.5 cm	250 litres
190x80	190 cm	80 cm	117.3 cm	57.5 cm	265 litres

OPTIONS



BATHTUB EDGE FITTINGS WITH CONSTANT FLOW

- cascade filling nozzle
- showerhead with anti-drip pipe
- temperature changer
- reverser

PANELLING

For installation in a corner, angle, U against the wall or free-standing

PANELLING FINISHES

WHITE
matching the bathtub



GLOSSY WHITE

MATTE WHITE

CLAY



PECE

TORTORA

POLVERE

WOOD



WHITE WOOD

GRAIN

BURLINGTON

WENGE

SENSE 3



SENSE 4

RECTANGULAR BATHTUB

Flat base



VERSIONS

EQUIPMENT

BUILT-IN WITH FEET

head cushions
Automatic emptying

WITH SELF-SUPPORTING FRAME

head cushions
Automatic emptying

	STANDARD WITHOUT WHIRLPOOL SYSTEM	RELAXED DREAM AIR AIR SYSTEM	TONIC HYDRO WATER SYSTEM	RELAXED + TONIC HYDRO PLUS MIXED SYSTEM	DREAM PLUS MIXED SYSTEM
BUILT-IN WITH FEET	•				
WITH SELF-SUPPORTING FRAME	•	•	•	•	•



GLOSSY
WHITE

MATTE
WHITE

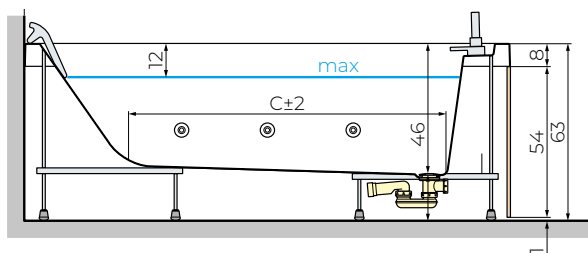
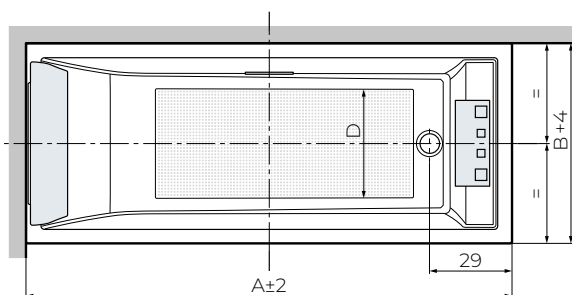

MODEL	A	B	C	D	CAPACITY
170x70	170 cm	70 cm	110.7 cm	47.5 cm	205 litres
170x75	170 cm	75 cm	110.7 cm	52.5 cm	225 litres
180x80	180 cm	80 cm	114.2 cm	57.5 cm	250 litres
190x80	190 cm	80 cm	117.3 cm	57.5 cm	265 litres

OPTIONS



BATHTUB EDGE FITTINGS WITH CONSTANT FLOW

- cascade filling nozzle
- showerhead with anti-drip pipe
- temperature changer
- reverser

PANELLING

For installation in a corner, angle, U against the wall or free-standing

PANELLING FINISHES

WHITE
matching the bathtub



GLOSSY
WHITE

MATTE
WHITE

CLAY



PECE

DOVE GREY

POLVERE

WOOD



WHITE
WOOD

GRAIN

BURLINGTON

WENGE



SENSE 4



SENSE COLLECTION

MASSAGE SYSTEMS

RELAXED

DREAM AIR

Air massage system

- 6 dorsal air injectors
- + 10 air injectors at the base
- 400 W



2 Air massage speeds, selectable
Adjustable massage duration



Chromolight: 4 light sequence programs with possibility to stop at a colour



Music reader stored on a telephone or tablet via Bluetooth connection



RDS Radio: FM channel transmission

SENSE 3 AND 4

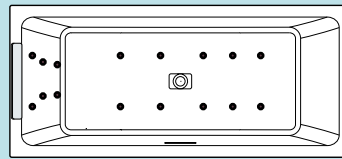

HYGIENE

AIR: Drying Air pipes at the end of the bath



Air injector with 5 outlets

RELAXED AND TONIC

HYDRO PLUS

Mixed massage system

- 6 dorsal air micro-jets
- + 10 air micro-jets at the base
- 400 W
- 6 adjustable lateral water nozzles
- + 2 adjustable plantar water nozzles
- 550 W



Continuous air massage
Adjustable massage duration



Water massage at variable speed or manual selection of the desired speed
Adjustable massage duration



Chromolight: 4 light sequence programs with possibility to stop at a colour



Music reader stored on a telephone or tablet via Bluetooth connection



Music reader stored on a telephone or tablet via Bluetooth connection



Disinfection program

SENSE 3 AND 4

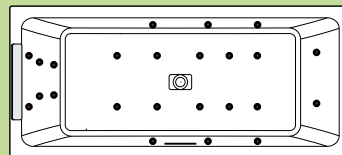

HYGIENE

AIR: Drying Air pipes at the end of the bath

WATER: Water pipe disinfection program.. Use the products customized for the whirlpool bathtubs to fill the tank planned for this purpose.



Air micro-jet



Rotatable water nozzle



BLUETOOTH MUSIC AND RDS RADIO

diffusion of music and FM radio channels by speakers placed under the cushion

Available with all systems of the Sense collection



MULTICOLOURED SPOT





sequences of lights to liven up your whirlpool sessions

Available with all systems of the Sense collection

TONIC

HYDRO

Water massage system
 • 2 plantar water nozzles
 + 6 water nozzles lateral
 550 W

-  Water Massage at variable speeds or manual selection of the desired speed Adjustable massage duration
-  Chromolight: 4 light sequence programs with possibility to stop at a colour
-  Music reader stored on a telephone or tablet via Bluetooth connection
-  RDS Radio: FM channel transmission
-  Disinfection program

SENSE 3 AND 4

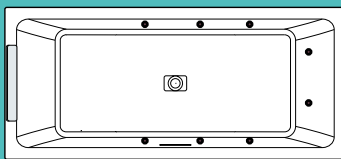

HYGIENE

WATER: Water stream disinfection program. Use the products customized for the whirlpool bathtubs to fill the tank planned for this purpose.









Rotatable water nozzle

RELAXED AND TONIC

DREAM PLUS

Mixed massage system
 • 10 air injectors at the base 400 W
 • 8 adjustable lateral water nozzles
 + 2 adjustable plantar water nozzles
 + 6 dorsal micro-water nozzles
 900 W

-  2 Air massage speeds, selectable Adjustable massage duration
-  Constant or alternate water massage Adjustable massage duration
-  Chromolight: 4 light sequence programs with possibility to stop at a colour
-  Music reader stored on a telephone or tablet via Bluetooth connection
-  RDS Radio: transmission of FM channels
-  Temperature re-heater: maintains the bath water temperature
-  Disinfection program

SENSE 3 AND 4

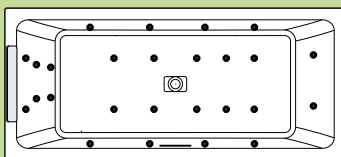

HYGIENE

AIR: Drying Air pipes at the end of the bath

WATER: Water pipe disinfection program.. Use the products customized for the whirlpool bathtubs to fill the tank planned for this purpose.



Air injector with 5 outlets



Water nozzle



Rotatable water nozzle



TEMPERATURE RE-HEATER-STABILIZER

maintains bath water temperature at its initial level when the Water massage is in progress

Available with the Dream Plus system

SENSE DUAL

TWO-SEAT BATHTUB

VERSIONS

WITH SELF-SUPPORTING FRAME

EQUIPMENT

2 head cushions
automatic emptying

STANDARD WITHOUT WHIRLPOOL SYSTEM	RELAXED + TONIC HYDRO PLUS MIXED SYSTEM
•	•

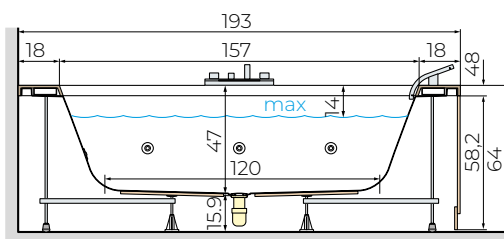
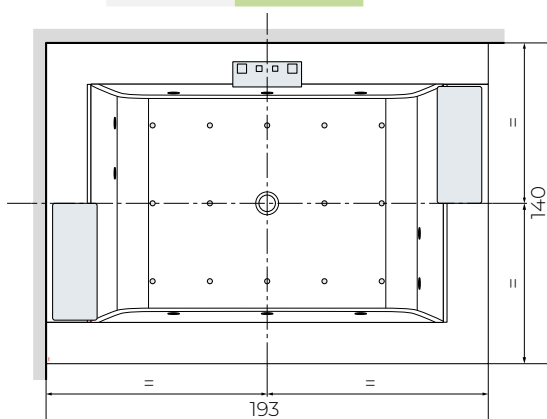

MODEL	CAPACITY
193x140 cm	450 litres

OPTIONS



- BATHTUB EDGE FITTINGS WITH CONSTANT FLOW
- cascade filling nozzle
 - showerhead with anti-drip pipe
 - temperature changer
 - reverser

PANELLING AND BATHTUB EDGES

Panelling for installation in a corner, angle, in a U against the wall or free-standing
Different combinations possible between the finish of the edge of the bathtub and the panelling

PANELLING FINISHES

WHITE
matching the bathtub



GLOSSY WHITE MATTE WHITE

WOOD



WHITE WOOD GRAIN BURLINGTON WENGE

SENSE DUAL









SENSE DUAL BATHTUB

MASSAGE SYSTEMS

RELAXED AND TONIC

HYDRO PLUS

- Mixed massage system
- 14 air injectors at the base
400 W
- 6 adjustable lateral water nozzles
+ 4 adjustable plantar water nozzles
550 W + 550 W

-  Massage with variable intensity or manual selection of the desired speed
Adjustable massage duration
-  Continuous massage
Adjustable massage duration
-  Chromolight: 4 programs of light sequences with the possibility to stop at one colour
-  Music reader stored on a telephone or tablet via Bluetooth connection
-  RDS Radio: transmission of FM channels
-  Temperature re-heater:
Maintains the bath water temperature
-  Disinfection program

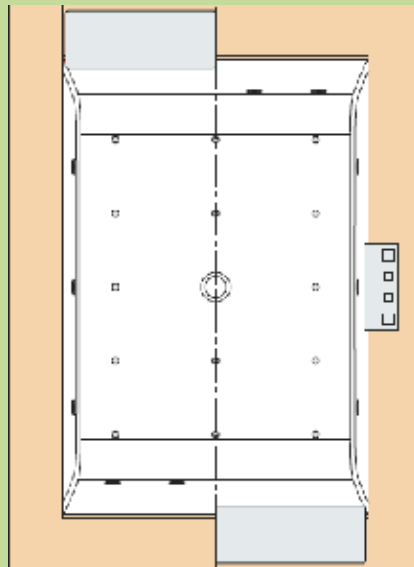

HYGIENE

- AIR:** Drying Air pipes at the end of the bath
- WATER:** Water pipe disinfection program. Use the products customized for the whirlpool bathtubs to fill the tank planned for this purpose



Flat air injector

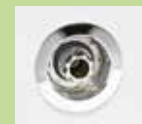

Rotatable water nozzle



BLUETOOTH MUSIC AND RDS RADIO
diffusion of music and FM radio channels via the speakers placed under the bathtub cushion



MULTICOLOURED LED LIGHT
LED light sequences to liven up your whirlpool sessions



TEMPERATURE RE-HEATER-STABILIZER
maintains bath water temperature at its initial level when the Water massage is in progress



BURRO OPTIMUS
POLENGHI LOMBARDO



LA MIGLIORE QUALITÀ DI BURRO



SENSE CLASSIC

INITIATION TO WHIRLPOOL MASSAGE

The Classic collection is perfect to step towards the discovery of the pleasures of a whirlpool.

This affordable collection offers a selection of bathtubs in traditional forms and essential massages. You will appreciate the simple operation and a selection of bathtubs that will easily integrate into the contemporary and classic ambiances.



Electronic keyboard with a sober design to enable easy massage monitoring.



The massage systems of the Classic collection perfectly suit all those who wish to try a whirlpool experience. Essential and affordable massages.



The classic design of these models enables integrating them easily in all types of ambiances. They benefit from top-of-the-line materials and our complete know-how in terms of design and well-being.



The ergonomic and hygienic head supports of the bathtubs in the Classic collection offer exceptional comfort (not available with built-in bathtubs).

CALOS 2.0

RECTANGULAR BATHTUB

VERSIONS

EQUIPMENT

STANDARD
WITHOUT WHIRLPOOL
SYSTEM

**TONIC
HYDRO**
WATER SYSTEM

HYDRO + DISINFECTION
WATER SYSTEM

**RELAXED + TONIC
HYDRO PLUS
MIXED SYSTEM**

**BUILT-IN
WITH FEET**

**WITH SELF-SUPPORTING
FRAME**

head cushions
Automatic emptying



GLOSSY
WHITE

MATTE
WHITE

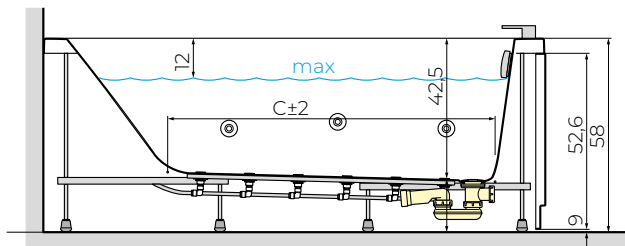
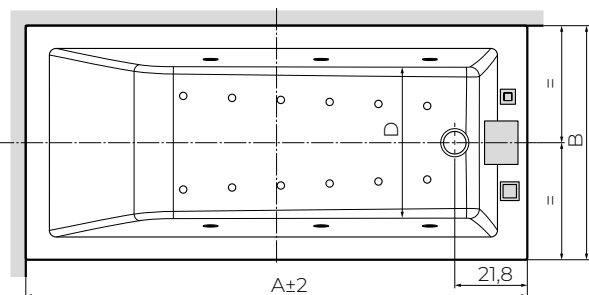

MODEL	A	B	C	D	CAPACITY
150x70	150 cm	70 cm	97.9 cm	44.4 cm	150 litres
160x70	160 cm	70 cm	108.1 cm	44.4 cm	160 litres
170x70	170 cm	70 cm	118.3 cm	44.4 cm	170 litres
170x75	170 cm	75 cm	118.3 cm	49.4 cm	180 litres
170x80	170 cm	80 cm	118.3 cm	54.4 cm	190 litres
180x80	180 cm	80 cm	128.5 cm	54.4 cm	200 litres

OPTIONS



**BATHTUB EDGE FITTINGS
WITH CONSTANT FLOW**

- cascade filling nozzle
- showerhead
- temperature changer
- reverser



FILLING BY EMPTYING
The bathtub filling is done by
the emptying wheel

PANELLING

For installation in a corner, angle or in U against the wall

PANELLING FINISHES



CALOS 2.0



CALYPSO

RECTANGULAR BATHTUB

Base with relief

VERSIONS

EQUIPMENT

BUILT-IN WITH FEET

WITH SELF-SUPPORTING FRAME

head cushions
Automatic emptying

	STANDARD WITHOUT WHIRLPOOL SYSTEM	TONIC HYDRO WATER SYSTEM	HYDRO + DISINFECTION WATER SYSTEM	RELAXED + TONIC HYDRO PLUS MIXED SYSTEM
BUILT-IN WITH FEET	•			
WITH SELF-SUPPORTING FRAME	•	•	•	•

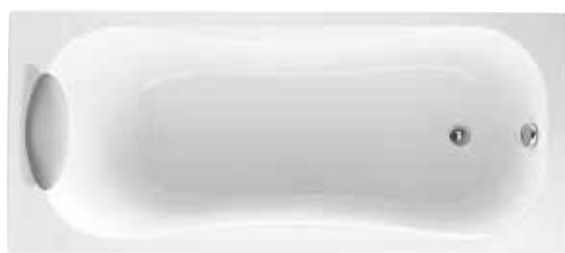

GLOSSY WHITE

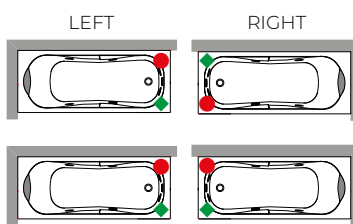

STANDARD VERSION

- FITTINGS
- ◆ HAND-HELD SHOWERHEAD

WHIRLPOOL VERSION

- FITTINGS
- ◆ HAND-HELD SHOWERHEAD

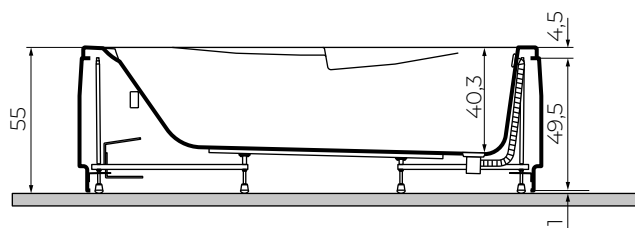
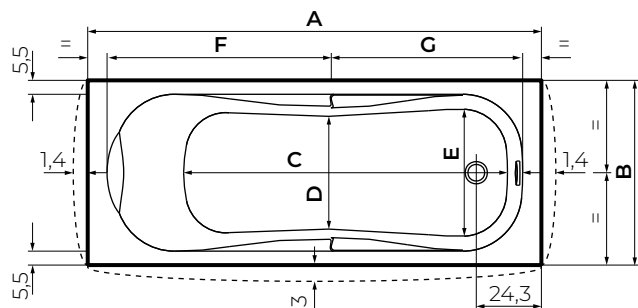

MODEL	A	B	C	D	E	F	G	CAPACITY
150x70	149.5 cm	69.5 cm	100 cm	42 cm	47 cm	73 cm	62.5 cm	150 litres
160x70	159.5 cm	69.5 cm	110 cm	42 cm	47 cm	78 cm	67.5 cm	160 litres
170x70	169.5 cm	69.5 cm	120 cm	42 cm	47 cm	83 cm	72.5 cm	170 litres
170x75	169.5 cm	74.5 cm	120 cm	47 cm	52 cm	83 cm	72.5 cm	180 litres
170x80	169.5 cm	79.5 cm	120 cm	50 cm	57 cm	83 cm	72.5 cm	190 litres
180x80	179.5 cm	79.5 cm	130 cm	50 cm	57 cm	88 cm	77.5 cm	200 litres

OPTIONS



BATHTUB EDGE FITTINGS WITH CONSTANT FLOW

- filling nozzle
- showerhead
- temperature changer
- reverser



FILLING BY EMPTYING
The bathtub filling is done by the emptying wheel

PANELLING

For installation in a corner, angle or in U against the wall

PANELLING FINISHES

WHITE

matching the bathtub



GLOSSY WHITE

CALYPSO



VOGUE

ASYMMETRIC BATHTUB AT AN ANGLE

Base with relief

VERSIONS

EQUIPMENT

BUILT-IN WITH FEET

WITH SELF-SUPPORTING FRAME

head cushions
Automatic emptying

STANDARD
WITHOUT WHIRLPOOL SYSTEM

TONIC HYDRO
WATER SYSTEM

HYDRO + DISINFECTION
WATER SYSTEM

RELAXED + TONIC
HYDRO PLUS
MIXED SYSTEM



GLOSSY WHITE

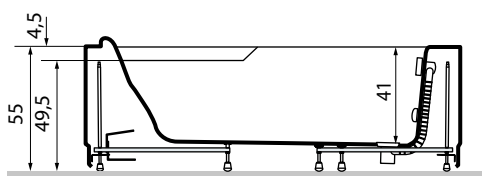
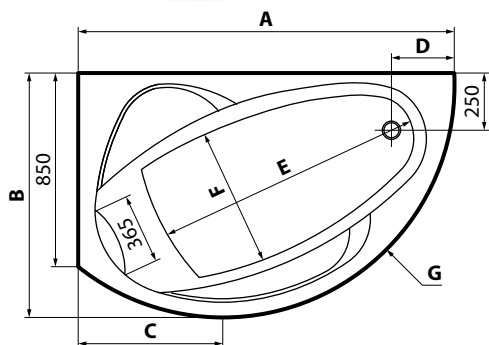

MODEL	A	B	C	D	E	F	G	CAPACITY
150x85	150 cm	101.5 cm	55 cm	29 cm	103 cm	58 cm	96.2 cm	140 litres
165x85	165 cm	107 cm	63 cm	28 cm	115 cm	64 cm	101.5 cm	180 litres

OPTIONS



BATHTUB EDGE FITTINGS WITH CONSTANT FLOW

- filling nozzle
- showerhead
- temperature changer
- reverser



FILLING BY EMPTYING
The bathtub filling is done by the emptying wheel

PANELLING

For installation in angle

PANELLING FINISHES

WHITE
matching the bathtub



GLOSSY WHITE

VOGUE





SENSE COMFORT

BATH AND SHOWER ALL-IN-ONE

No more need to select between the practicality of the shower and the comfort of the bathtub. The bathtub with an elegant and designed Iris door will please the whole family.

It's also an ideal solution for average size bathrooms. You will be charmed by its perfect finishing and the selection of panelling design.

The massages available with the Iris bathtub will simply awaken your senses.



Electronic keyboard with a sober design to enable easy massage monitoring.



The massage systems of the Comfort collection offer essential massages with easy operation.



Thanks to its door with 8 mm security glass, the Iris bathtub offers easy access. Complete with a bath screen, it also offers a practical showering space.



All the details have been thought out to give you maximum comfort. Placed on the outer edge of the bathtub, the fittings are easily accessible. And the head rest of the Iris bathtub easily transforms into a seat

IRIS

WALK-IN FAMILY BATHTUB

STANDARD WITHOUT WHIRLPOOL SYSTEM	TONIC HYDRO + DISINFECTION WATER SYSTEM	RELAXED + TONIC HYDRO PLUS MIXED SYSTEM
•	•	•

VERSIONS

WITH SELF-SUPPORTING FRAME

EQUIPMENT

head cushions
Automatic emptying



GLOSSY WHITE

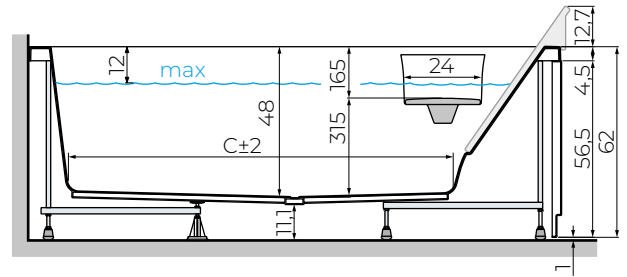
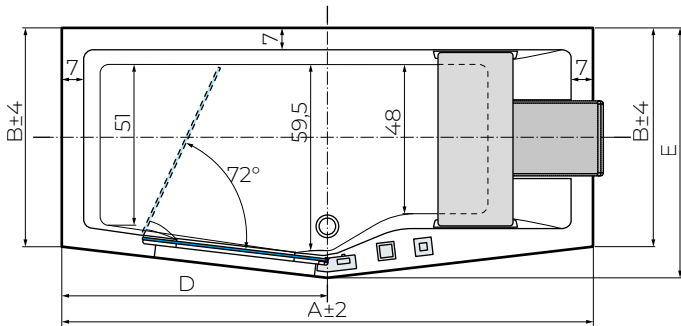

MODEL	A	B	C	D	E	CAPACITY
160x70/80	160 cm	70 cm	114 cm	86 cm	80 cm	250 litres
170x70/80	170 cm	70 cm	123.5 cm	85 cm	80 cm	265 litres
180x75/80	180 cm	75 cm	134.5 cm	86 cm	85 cm	305 litres

OPTIONS



BATHTUB EDGE FITTINGS WITH CONSTANT FLOW

- showerhead
- temperature changer
- filling by emptying



FILLING BY EMPTYING
The bathtub filling is done by the emptying wheel



BATH SCREEN
Transparent 6 mm safety glass with water-repellent treatment
Outline: Chrome
Iris Comby:
for installation in angle
Iris Comby 2:
for installation in U



HEAD REST
For installation in a corner.
Cannot be used as a seat
Dimensions: 56 x 24 cm
By replacing the head rest of the series delivered with the bathtub.

PANELLING

For installation in a corner, angle or in U against the wall

PANELLING FINISHES

WHITE
matching the bathtub



GLOSSY WHITE

WOOD



WHITE WOOD



GRAIN



BURLINGTON



WENGE



TONIC

HYDRO

Water massage system
 • 6 adjustable lateral water nozzles
 550 W

 Water Massage On/ Off

CALOS 2.0

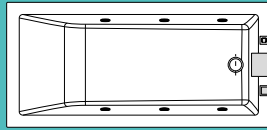

CALYPSO

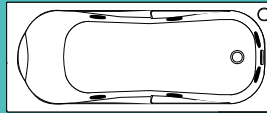

VOGUE

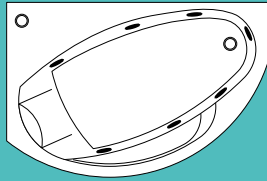

HYGIENE

WATER: Use the products customized for the whirlpool bathtubs to disinfect the water stream: fill your bathtub, pour the product in the bath water and start the Water massage



Adjustable water nozzle

TONIC

HYDRO + DISINFECTION

Water massage system
 • 6 adjustable lateral water nozzles
 550 W

 Water Massage with variable speed with the possibility to stop at a speed

 Disinfection program

CALOS 2.0

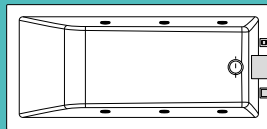

CALYPSO

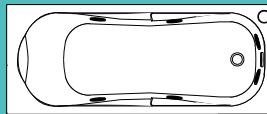

VOGUE

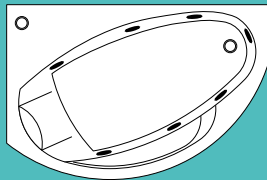

HYGIENE

WATER: Water pipe disinfection program.. Use the products customized for the whirlpool bathtubs to fill the tank planned for this



Adjustable water nozzle

RELAXED AND TONIC

HYDRO PLUS

Mixed massage system
 • 14 base air injectors
 400 W
 • 6 adjustable lateral water nozzles
 550 W

 Air Massage continuous or alternate

 Water Massage with variable speed with the possibility to stop at a speed

 Disinfection program

CALOS 2.0

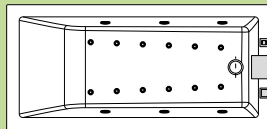

CALYPSO

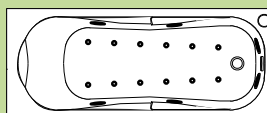

VOGUE

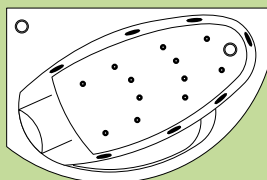

HYGIENE

AIR: Drying Air pipes at the end of the bath

WATER: Water pipe disinfection program.. Use the products customized for the whirlpool bathtubs to fill the tank planned for this



Air injector





Adjustable water nozzle

TONIC

HYDRO + DISINFECTION

Water massage system
 • 6 adjustable lateral water nozzles
 550 W

-  Water Massage with variable speed with the possibility to stop at a speed
-  Disinfection program

IRIS

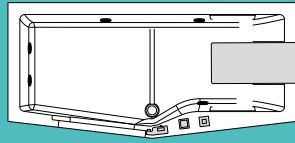

HYGIENE

WATER: Water pipe disinfection program.. Use the products customized for the whirlpool bathtubs to fill the tank planned for this





Adjustable water nozzle

RELAXED AND TONIC

HYDRO PLUS

Mixed massage system
 • 14 base injectors
 400 W
 • 16 adjustable lateral nozzles
 550 W

-  Air Massage continuous or alternate
-  Water Massage with variable speed with the possibility to stop at a speed
-  Disinfection program

IRIS

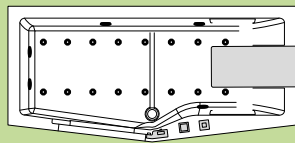

HYGIENE

AIR: Drying Air pipes at the end of the bath

WATER: Water pipe disinfection program.. Use the products customized for the whirlpool bathtubs to fill the tank planned for this

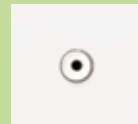

Air injector

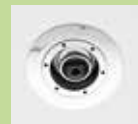

Adjustable water nozzle



SENSE NOVOTECH

EXCLUSIVE DESIGN AND TOP-OF-THE-LINE MATERIALS

This exclusive collection has a real masterpiece. Made of Novotech, a material with a high percentage of natural mineral fillers and highly pure resins, it offers two bathtub models in soft and curvy models. Particularly sold, these bathtubs have silk-touch surfaces. A real pleasure for the eyes and senses!



The interior of the bathtubs are done in Matte white finish. The exterior, on the other hand, can be personalized in 18 colours, to meet the requirements of the finest taste. You can select warm and enveloping hues or stronger and decisive ones.



The additionally proposed console adds to the functionality of the bathtubs. Equipped with fittings in essential design, it houses all the technological elements. You can opt for a wood finish or select a colour variant corresponding to the bathtub finish.



The Natural Air system that can complete your bathtub from the Novotech collection offers the Care massage with air micro bubbles with regenerative and relaxing properties. To allow you to savour your wellness experience, the insides of the bathtubs have been studied to provide you optimal immersion.



To create an intimate ambiance, the bathtubs can be optionally embellished with peripheral LED lighting.

INFINITIVE

FREE-STANDING BATHTUB

VERSIONS	EQUIPMENT	STANDARD WITHOUT WHIRLPOOL SYSTEM	CARE NATURAL AIR MICRO AIR BUBBLE SYSTEM
TO BE PLACED ALONE	snap emptying	•	
WITH FURNISHINGS AND ACCESSORIES	snap emptying	•	•

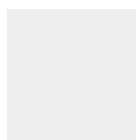

MATTE
WHITE

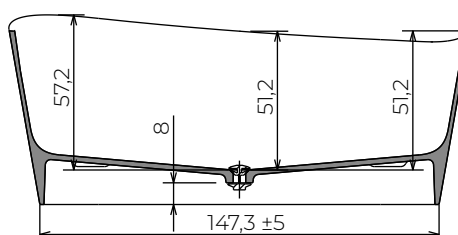
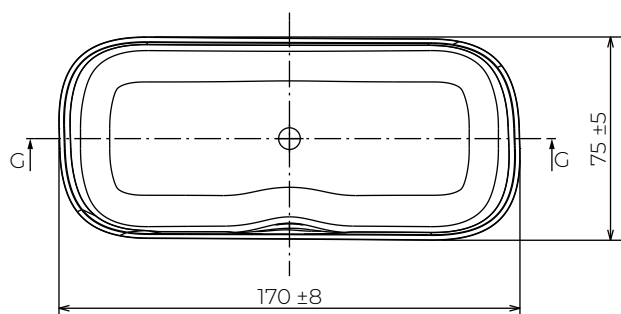

MODEL	WEIGHT	CAPACITY
170x75	135 kg	360 litres

EXTERNAL FINISHING OF THE BATHTUB AND CONSOLE

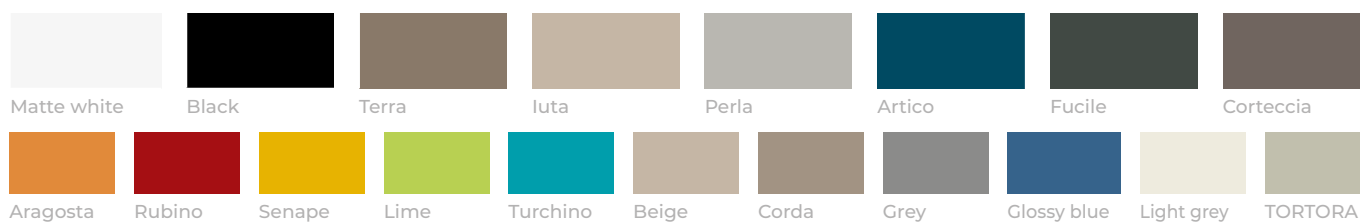

CONSOLE FINISHING



CONSOLE VERSIONS



OPTIONS



PERIPHERAL LED LIGHTING

INFINITIVE



SHIP

FREE-STANDING BATHTUB

VERSIONS	EQUIPMENT	STANDARD WITHOUT WHIRLPOOL SYSTEM	CARE NATURAL AIR MICRO AIR BUBBLE SYSTEM
TO BE PLACED ALONE	snap emptying	•	
WITH FURNISHINGS AND ACCESSORIES	snap emptying	•	•

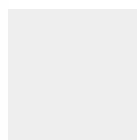

MATTE
WHITE

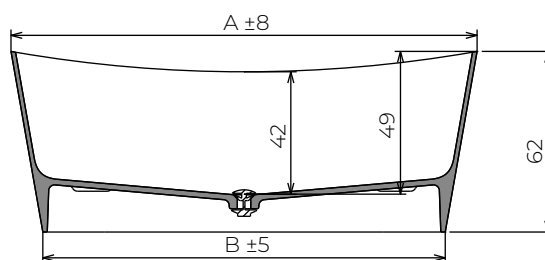
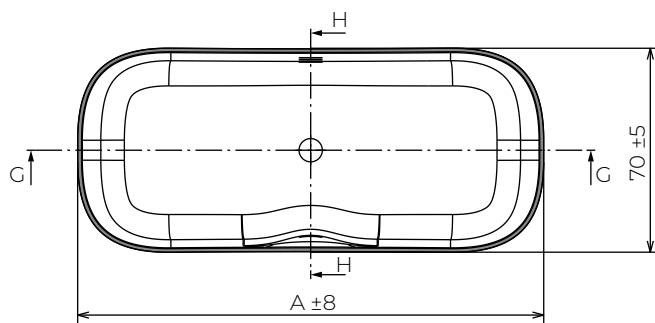

MODEL	A	B	WEIGHT	CAPACITY
150x70	150 cm	128 cm	105 kg	260 litres
160x70	160 cm	138 cm	115 kg	290 litres

EXTERNAL FINISHING OF THE BATHTUB AND CONSOLE

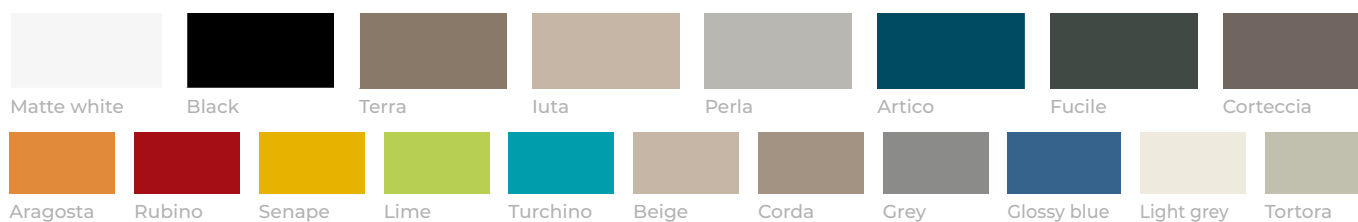

CONSOLE FINISHING



CONSOLE VERSIONS



OPTIONS



PERIPHERAL LED LIGHTING

SHIP



NOVOTECH COLLECTION

MASSAGE SYSTEMS

CARE

NATURAL AIR

Massage system with air micro bubbles

- 1 dispenser Natural Air
1,050 W



Air micro bubble diffusion in the bath water
Operation in start/ stop mode

INFINITIVE

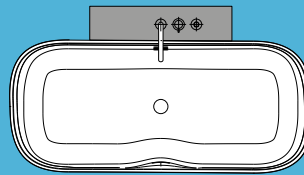

SHIP

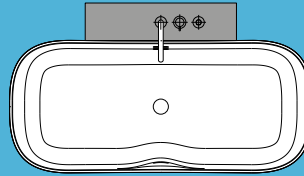

Natural Air diffuser backlit



NATURAL AIR
DIFFUSER



COMFORT			
Self-supporting frame	Head cushions	Emptying	Control



DIVINA
DIVINA 35
160x70 cm
170x70 cm
170x75 cm
180x80 cm
180x100 cm
190x90 cm

DIVINA F
DIVINA F 35
180x80 cm

DIVINA C
140x140 cm

DIVINA O
165x98 cm

DIVINA

Built-in with feet			snap	
With self-supporting frame	yes	yes	snap	
AIR INJECTORS	yes	yes	snap	Keyboard sensitive
HYDRO	yes	yes	snap	Keyboard sensitive
HYDRO PLUS	yes	yes	snap	Keyboard sensitive
NATURAL AIR	yes	yes	snap	Keyboard sensitive
NATURAL AIR + WHIRLPOOL	yes	yes	snap	Keyboard sensitive



DIVINA DUAL
190x140 cm

DIVINA DUAL

With self-supporting frame	yes	yes x2	snap	
WATER NOZZLES	yes	yes x2	snap	Keyboard sensitive
WHIRLPOOL + CASCADE	yes	yes x2	snap	Keyboard sensitive
WHIRLPOOL + AIRPOOL	yes	yes x2	snap	Keyboard sensitive
NATURAL AIR + WHIRLPOOL	yes	yes x2	snap	Keyboard sensitive
NATURAL AIR + WHIRLPOOL + CASCADE	yes	yes x2	snap	Keyboard sensitive



SENSE 3
base recliner
170x70 cm
170x75 cm
180x80 cm
190x80 cm



SENSE 4
base flat
170x70 cm
170x75 cm
180x80 cm
190x80 cm

SENSE

Built-in with feet		yes		
With self-supporting frame	yes	yes	automatic	
DREAM AIR	yes	yes	automatic	Remote control
HYDRO	yes	yes	automatic	Remote control
HYDRO PLUS	yes	yes	automatic	Remote control
DREAM PLUS	yes	yes	automatic	Remote control



SENSE DUAL
193x140 cm

SENSE DUAL

With self-supporting frame	yes	yes x2	automatic	
HYDRO PLUS	yes	yes x2	automatic	Remote control



CALOS 2.0
150x70 cm
160x70 cm
170x70 cm
170x75 cm
170x80 cm
180x80 cm



CALYPSO
150x70 cm
160x70 cm
170x70 cm
170x75 cm
170x80 cm
180x80 cm



VOGUE
150x85 cm
165x85 cm



IRIS
160x70/80 cm
170x70/80 cm
180x75/85 cm

CLASSIC AND COMFORT

Built-in with feet				
With self-supporting frame	yes	yes	automatic	
HYDRO	yes	yes	automatic	Keyboard electronic
HYDRO + DISINFECTION	yes	yes	automatic	Keyboard electronic
HYDRO PLUS	yes	yes	automatic	Keyboard electronic



INFINITIVE
170x75 cm



SHIP
150x70 cm
160x70 cm

NOVOTECH

Standard			snap	
NATURAL AIR			snap	

WATER		AIR		NATURAL AIR		CASCADE	WELLNESS			MAINTENANCE	
Pump	Nozzles	Wind tunnel	Diffusers	Pump	Diffusers	Pump	Music	Chromolight	Temperature re-heater-stabilizer	Drying automatic (Air)	Disinfection (Water)

		400 W	16 air injectors							yes	
900 W	6 nozzles water strip										
900 W	6 nozzles water strip	400 W	16 air injectors				Bluetooth	Backlit nozzles		yes	
				1,050 W	1 diffuser			Diffuser white LED			
900 W	6 nozzles water strip			1,050 W	1 diffuser		Bluetooth	Backlit nozzles			

900 W + 900 W	8 nozzles water strip										
900 W + 900 W	8 nozzles water strip					550 W	Bluetooth	Backlit nozzles			Automatic program
900 W + 900 W	8 nozzles water strip	400 W	20 air injectors				Bluetooth	Backlit nozzles		yes	Automatic program
900 W + 900 W	8 nozzles water strip			1,050 W	2 diffusers		Bluetooth	Backlit nozzles	1,300 W		Automatic program
900 W + 900 W	8 nozzles water strip			1,050 W	2 diffusers	550 W	Bluetooth	Backlit nozzles	1,300 W		Automatic program

		400 W	10 air injectors with 5 outlets				Bluetooth RDS Radio	Multicoloured spot		yes	
550 W	8 adjustable nozzles						Bluetooth RDS Radio	Multicoloured spot			Automatic program
550 W	8 adjustable nozzles	400 W	16 air micro-jets				Bluetooth RDS Radio	Multicoloured spot		yes	Automatic program
900 W	10 adjustable nozzles + 6 micro-nozzles	400 W	10 air injectors with 5 outlets				Bluetooth RDS Radio	Multicoloured spot	1,300 W	yes	Automatic program

550 W + 550 W	10 water nozzles	400 W	14 air injectors				Bluetooth RDS Radio	Led light	1,450 W	yes	Automatic program

550 W	6 adjustable water nozzles										
550 W	6 adjustable water nozzles										Automatic program
550 W	6 adjustable water nozzles	400 W	14 air injectors							yes	Automatic program

				1,050 W	1 diffuser			Diffuser white LED			



Novellini UK Ltd

Unit 11, Caxton Court - Porters Wood - St Albans - Hertfordshire - AL3 6XT
Tel: 01727-229922 - Fax: 01727-838232 - info-uk@novellini.com

Designed and
manufactured
in **ITALY**



www.novellini.com



www.novellini.com/facebook



www.novellini.com/instagram



www.novellini.com/YouTube



www.novellini.com/Linkedin



www.novellini.com/Pinterest